



US00D585519S

(12) **United States Design Patent**
Pennington

(10) **Patent No.:** **US D585,519 S**

(45) **Date of Patent:** **** Jan. 27, 2009**

(54) **STUN GUN**

(57) **CLAIM**

(76) Inventor: **Billy Pennington**, 414 S. Pulaski St.,
Suite 1, Little Rock, AR (US) 72201

The ornamental design for a stun gun, as shown and described.

(**) Term: **14 Years**

DESCRIPTION

(21) Appl. No.: **29/282,236**

FIG. 1 is a top plan view of a single element stun gun showing my new design;

(22) Filed: **Jul. 14, 2007**

FIG. 2 is a left elevation view of a single element stun gun;

(51) **LOC (9) Cl.** **22-02**

FIG. 3 is a bottom plan view of a single element stun gun;

(52) **U.S. Cl.** **D22/117**

FIG. 4 is a perspective view of a single element stun gun;

(58) **Field of Classification Search** **D22/117,**
D22/118, 199, 105; 42/1.08; 222/175, 183;
361/232

FIG. 5 is a bottom perspective view of a single element stun gun;

See application file for complete search history.

FIG. 6 is a front perspective view of a single element stun gun;

(56) **References Cited**

FIG. 7 is a bottom perspective view of a single element stun gun;

U.S. PATENT DOCUMENTS

FIG. 8 is a front elevation view of a single element stun gun;

D351,639	S	10/1994	Su	
6,256,916	B1	7/2001	McNulty	
6,636,412	B2	10/2003	Smith	
6,807,762	B1	10/2004	Edwards	
D530,777	S *	10/2006	Rhee	D22/117
D539,376	S *	3/2007	Rhee	D22/117
D539,866	S *	4/2007	Rhee	D22/117
D552,207	S *	10/2007	Rhee	D22/117

FIG. 9 is a front perspective view of a double element alternative embodiment of a stun gun;

* cited by examiner

FIG. 10 is a front elevation view of a double element alternative embodiment of a stun gun;

Primary Examiner—Catherine R Oliver
(74) *Attorney, Agent, or Firm*—Crossley Patent Law; Mark A. Crossley

FIG. 11 is a left perspective of a double element alternative embodiment of a stun gun;

FIG. 12 is a front elevation view of a double element alternative embodiment of a stun gun; and,

FIG. 13 is a rear elevation view of a double element alternative embodiment of a stun gun.

1 Claim, 13 Drawing Sheets

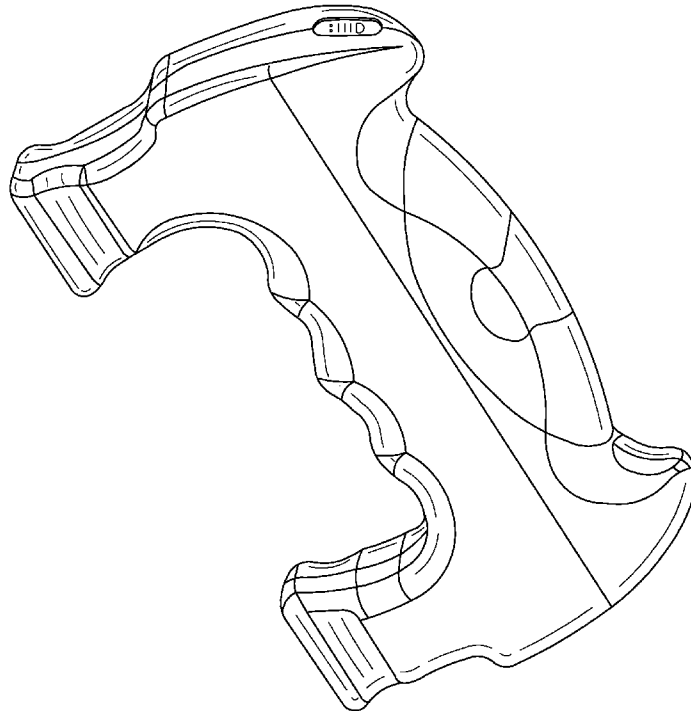

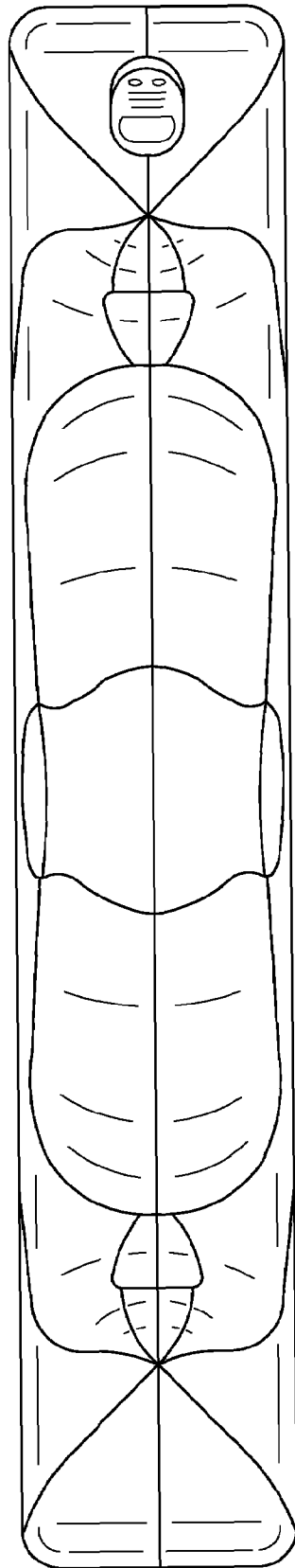

FIG. 1

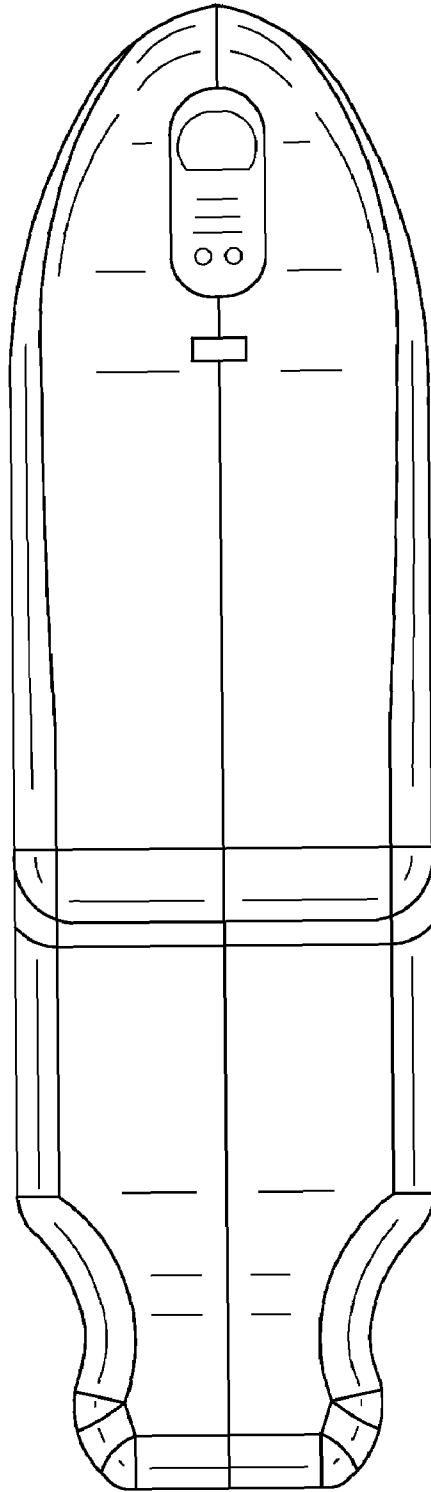

FIG. 2

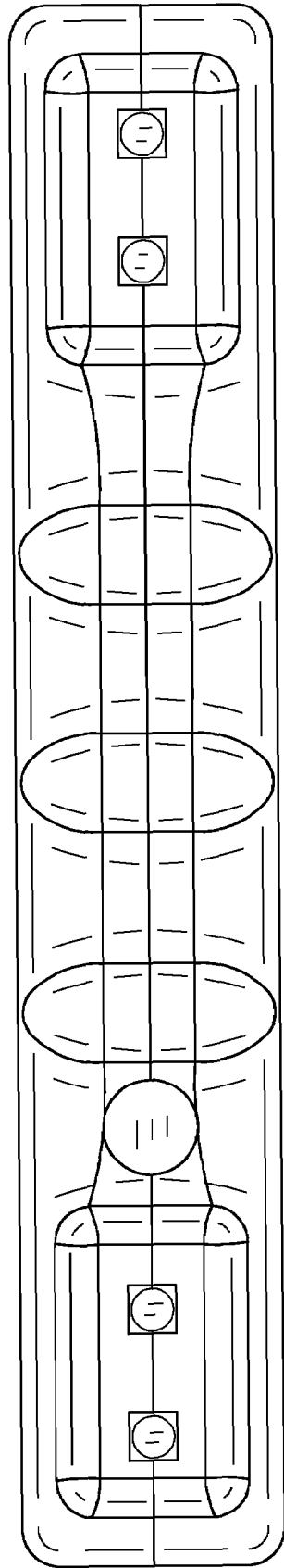

FIG. 3

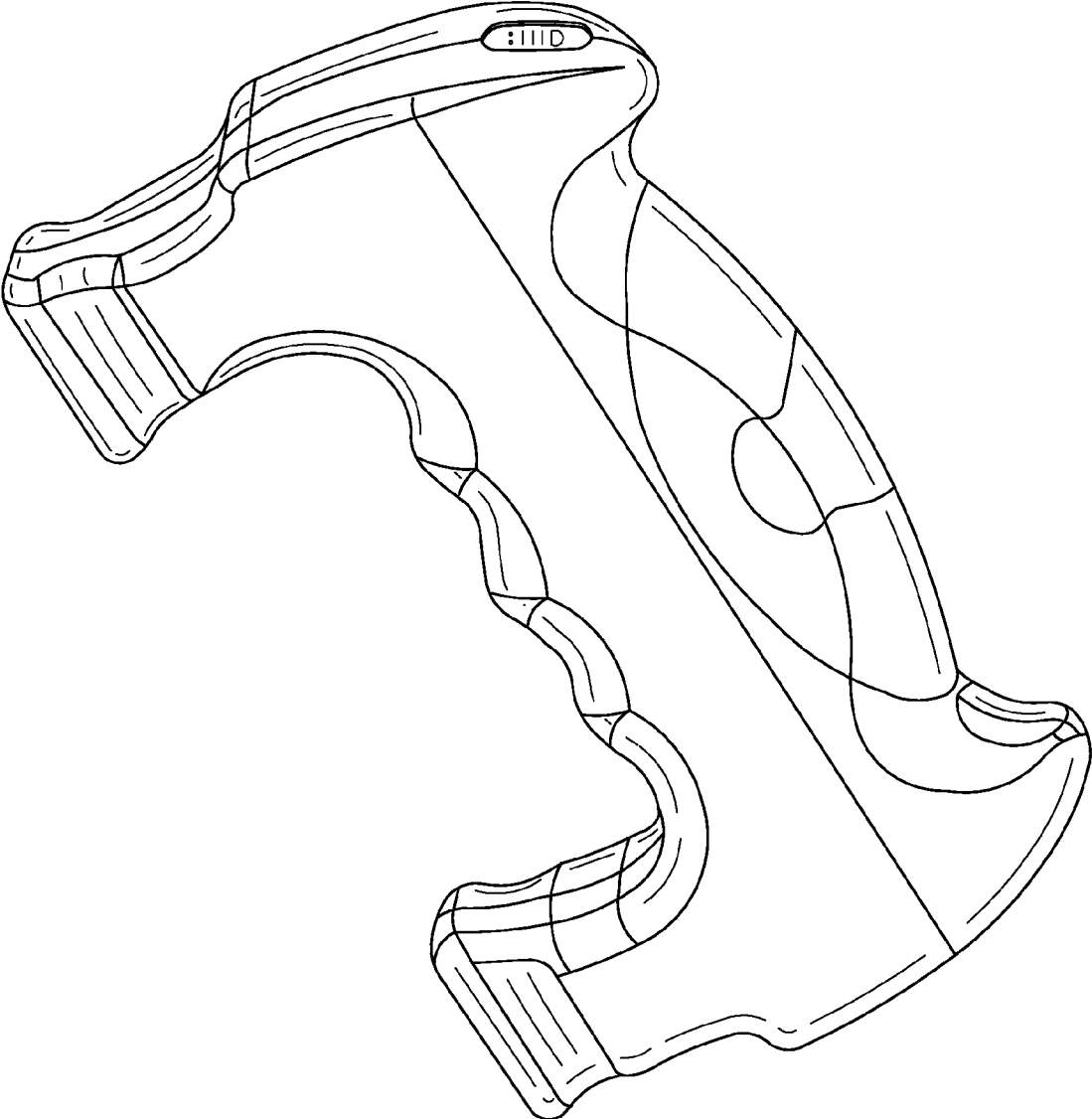

FIG. 4

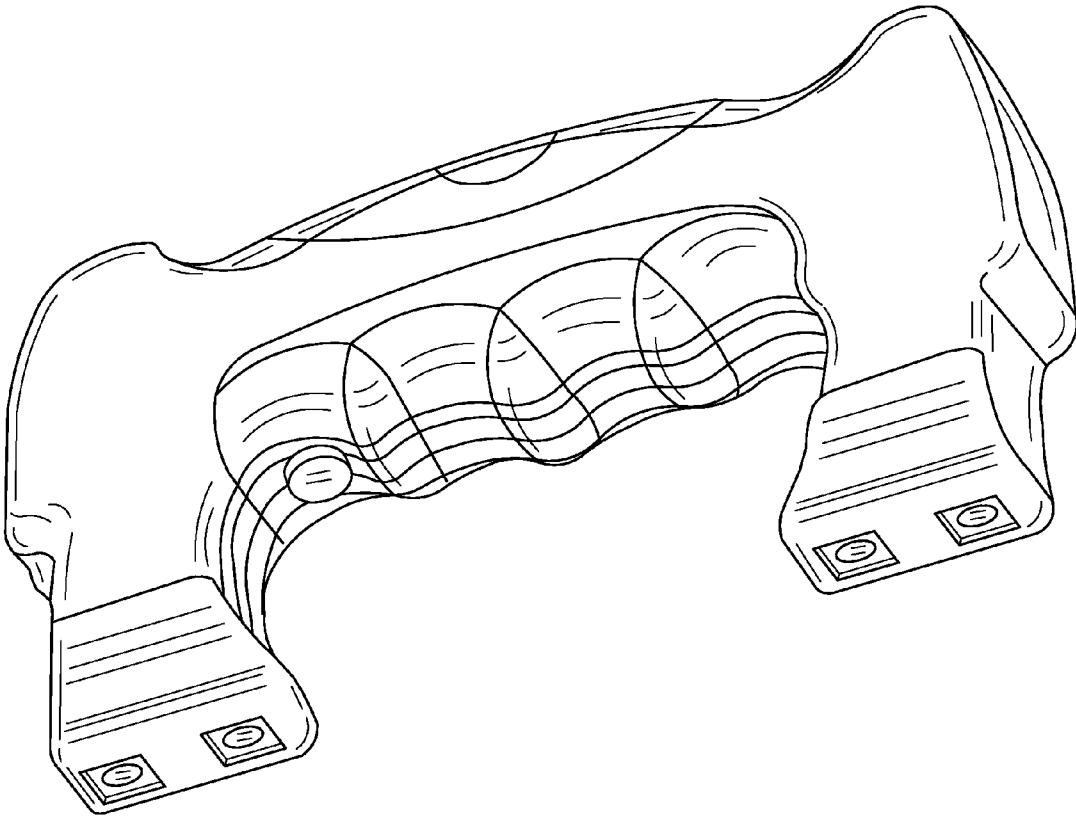

FIG. 5

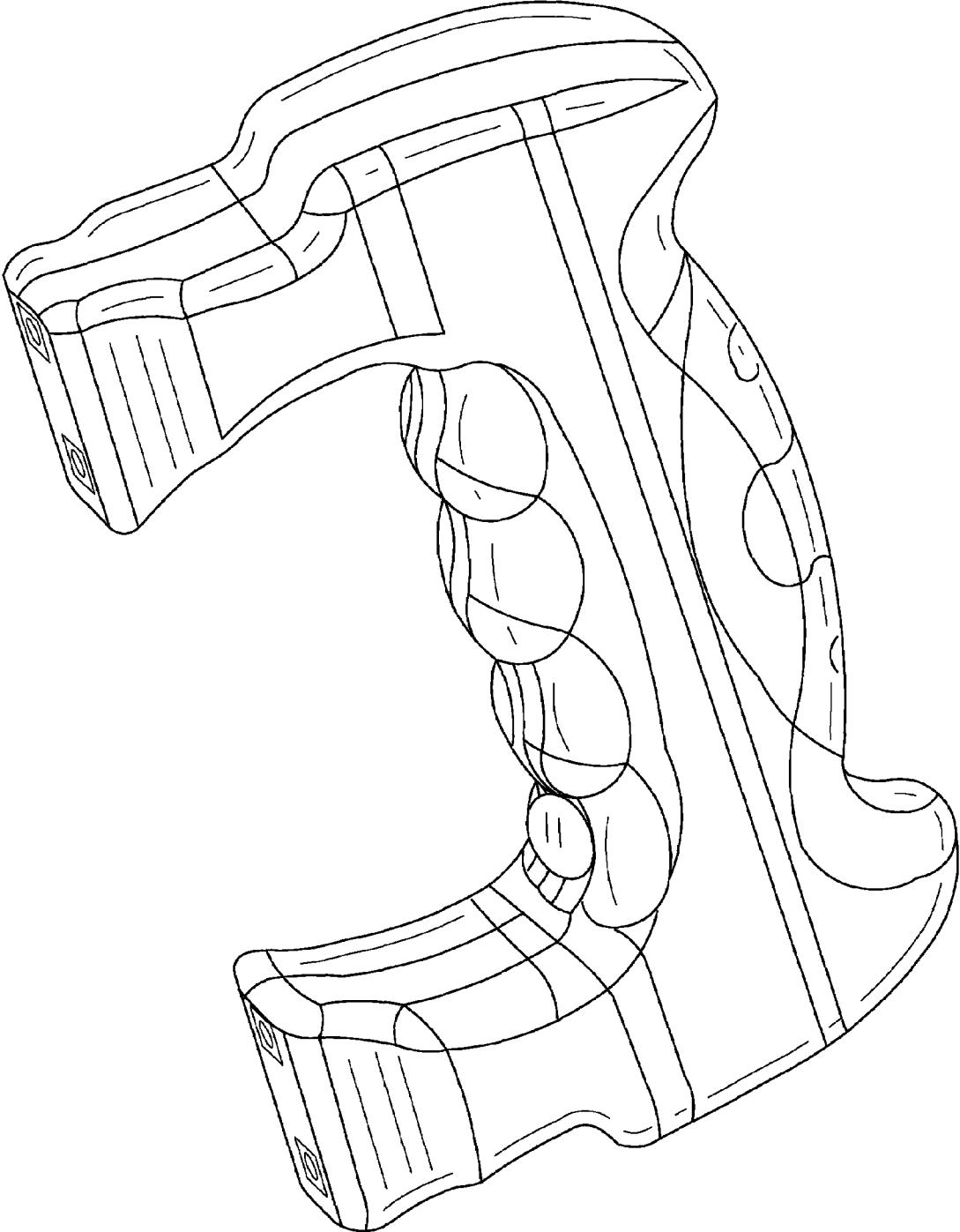

FIG. 6

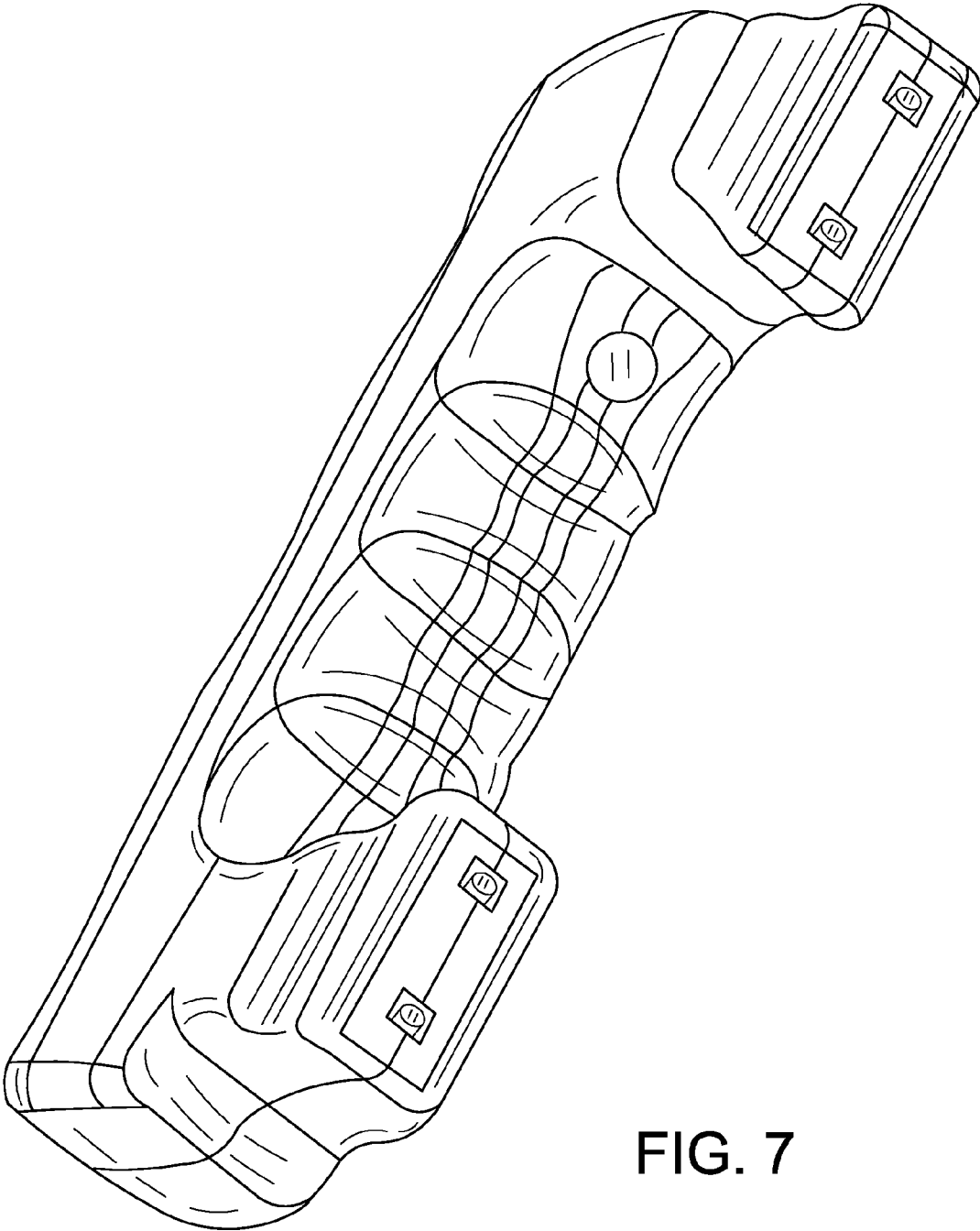

FIG. 7

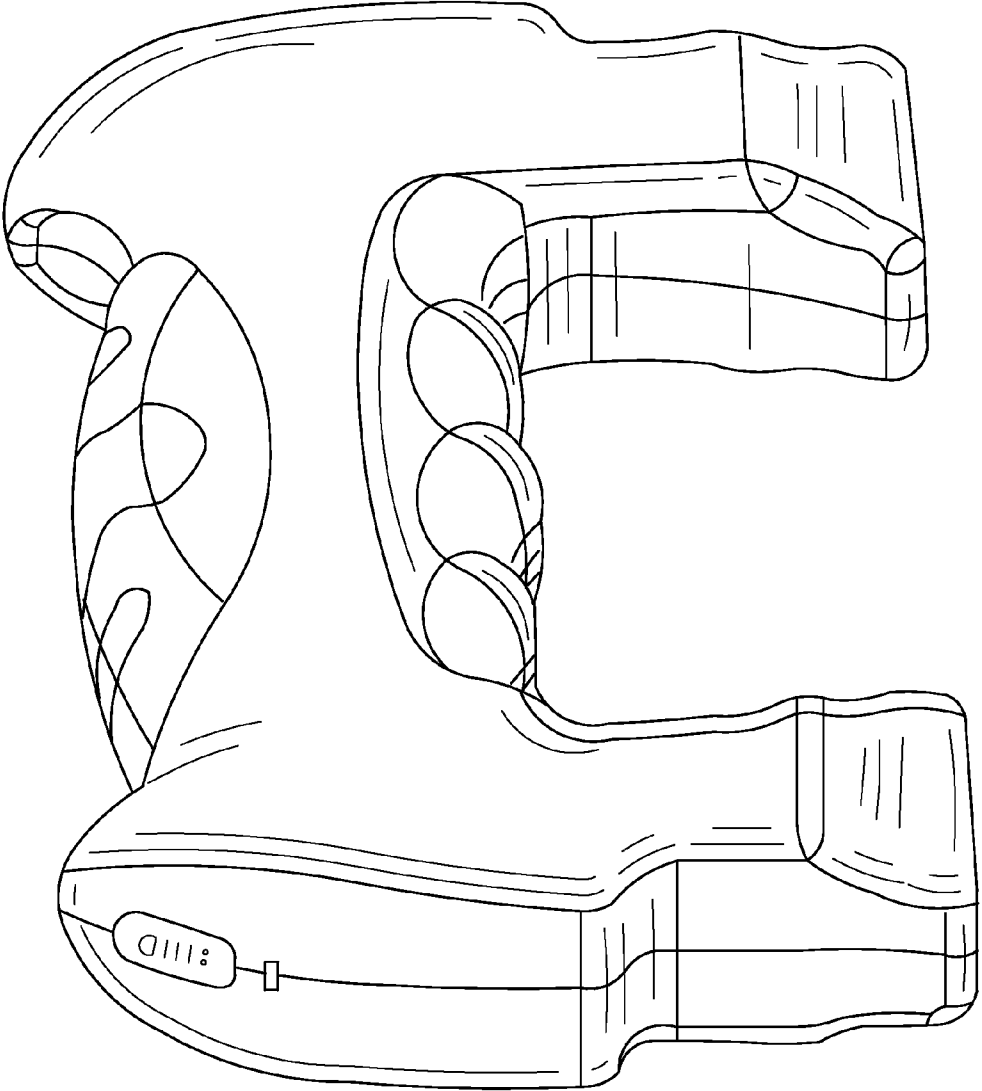

FIG. 8



FIG. 9

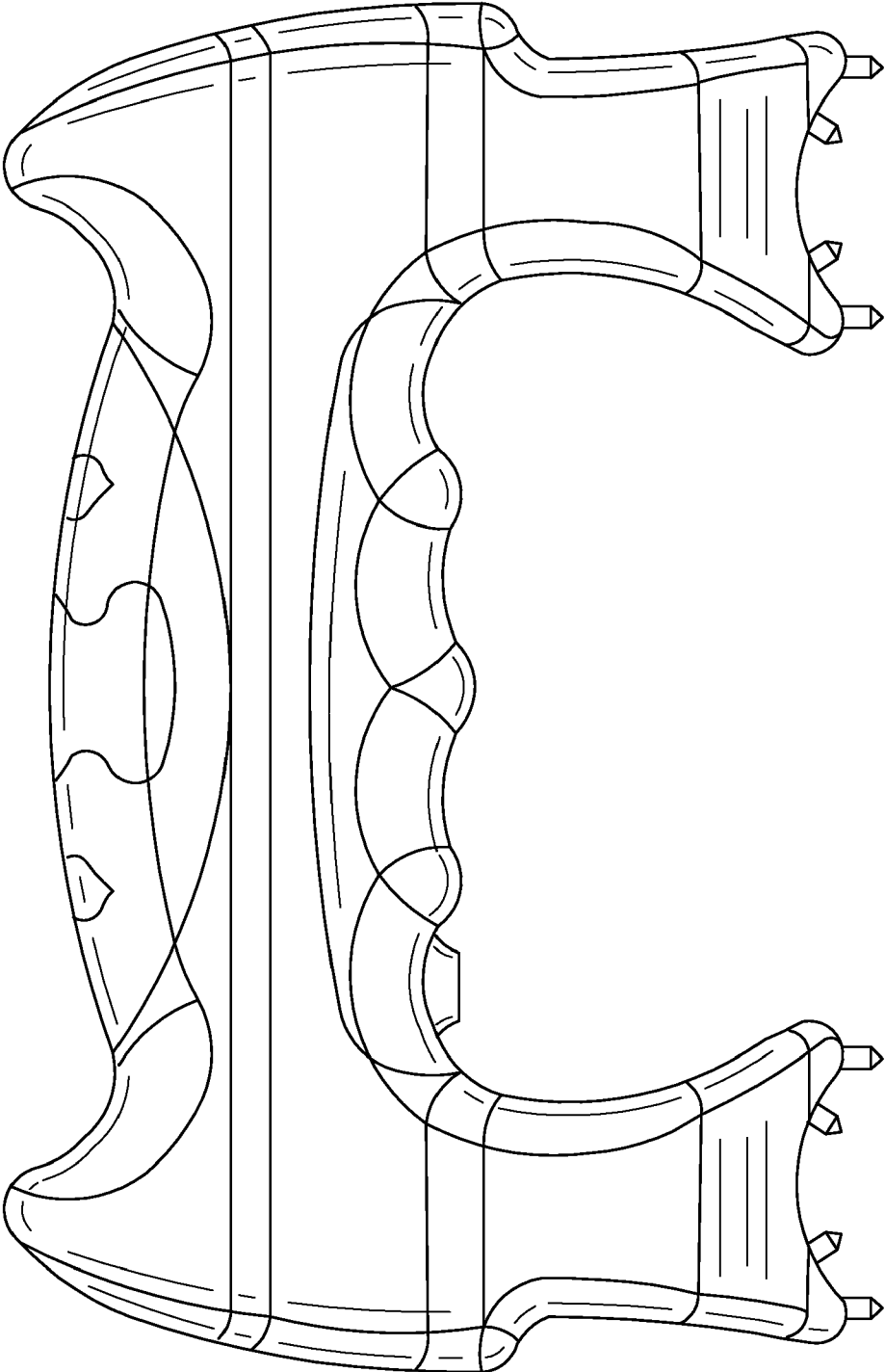

FIG. 10

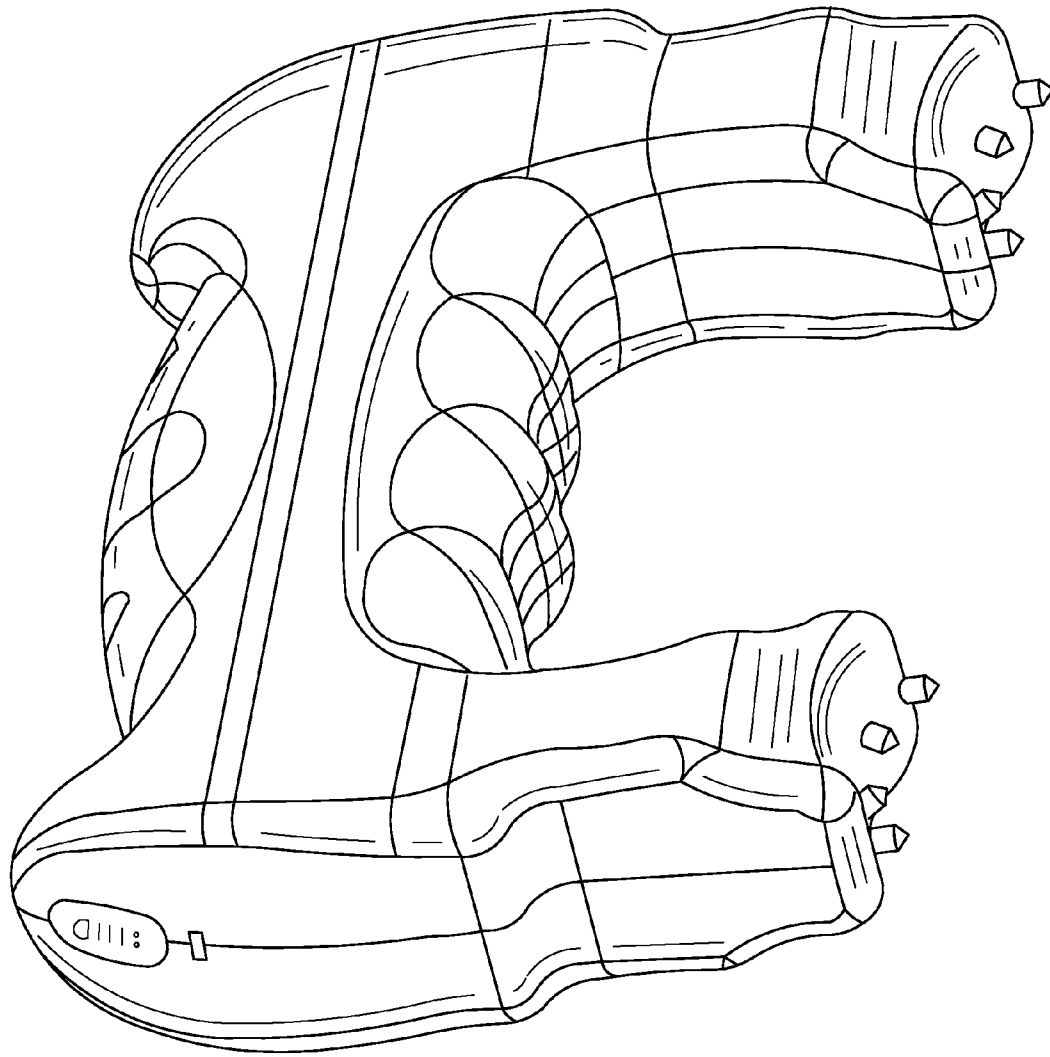

FIG. 11

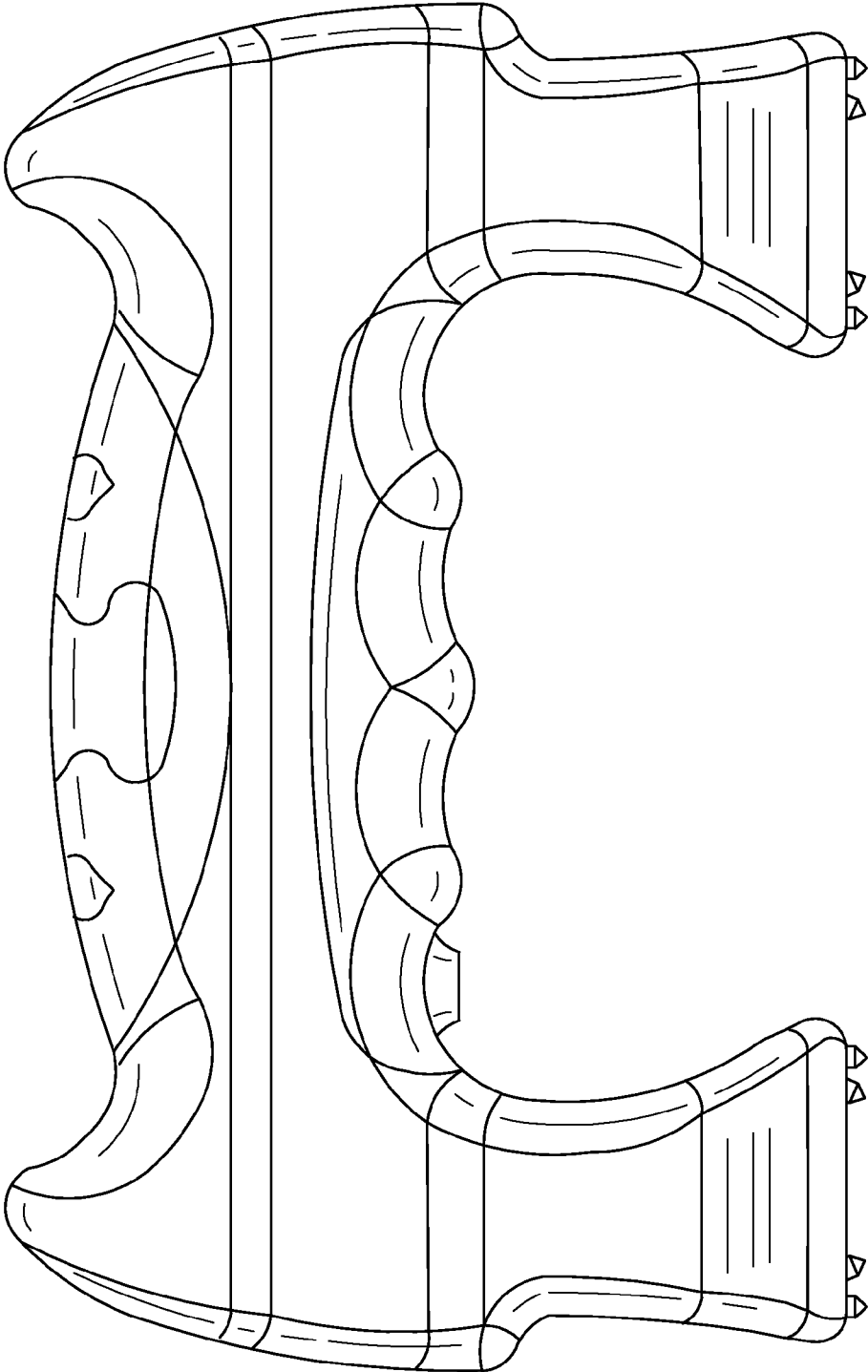

FIG. 12

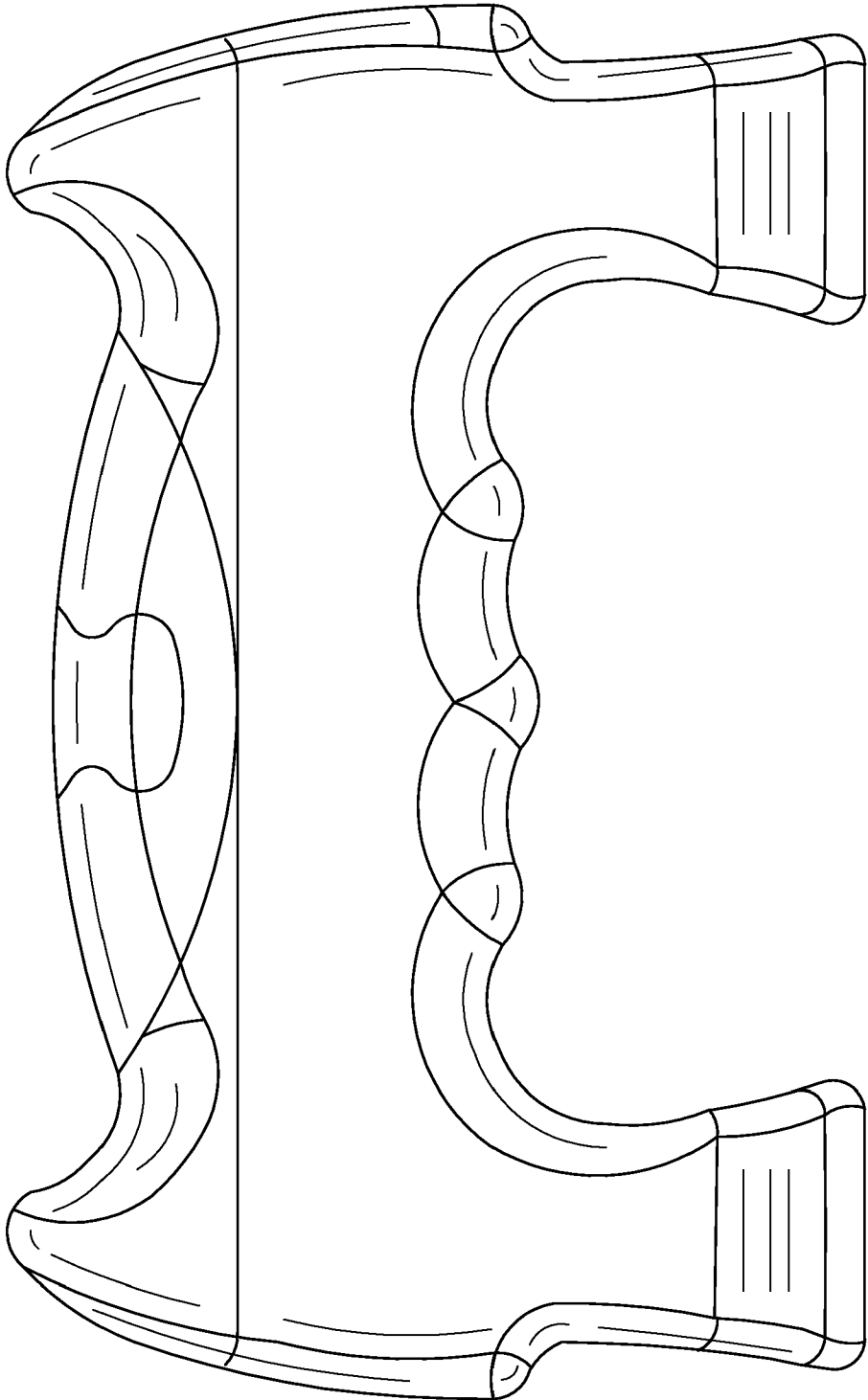

FIG. 13